

HERITAGE
~ HOMES ~



Let your Heritage start with us





WELCOME TO HERITAGE HOMES

At Heritage Homes we pride ourselves in building Villas, Bungalows and Cottages that never date. We work closely with every client to build a timeless home to match their budget. All our homes are built with your needs in mind and are built to today's specifications.

Browse through this catalogue, pick a design and plan and then call us today on 0508 40 30 20 or head to www.heritagehomes.nz and contact your closest Heritage Homes sales team. You have total control from the beginning.

Let Your Heritage Start With Us.

PROUDLY NZ OWNED AND OPERATED:

Heritage Homes was founded by the late Master craftsman Keith Mitchell. His vision was to create new builds with today's specifications that can withstand the test of time.

His son John has continued with this vision and today we are building Heritage Homes all over New Zealand for Kiwi families.

A Heritage Home that you and your family can love for generations.

OUR GUARANTEE

At Heritage Homes we know that your home is often your most valuable financial asset. That is why we offer comprehensive guarantees to cover all aspects of the build to protect you and your home.

Once we have given you a fixed price contract, we guarantee that price. No surprises, no hidden costs, no worries.

We also offer the comprehensive Master Builder 10 Year Guarantee on every home we build which includes: Completion Cover, Builders Cover and Structural Cover from the oldest most trusted independent building association in New Zealand.

Contact Us Today.

0508 40 30 20

WWW.HERITAGEHOMES.NZ



CONTENTS

Welcome to Heritage Homes.....	ii	
Villa The Petite Avondale	2	2 Bedroom
Villa The Petite Newmarket.....	4	
Pioneer The Waipu.....	6	
Pioneer The Riverton.....	7	
Cottage The Woodlands.....	8	
Villa The Avondale.....	10	3 Bedroom
Villa The Bayswater	12	
Villa The Newmarket + Garage.....	14	
Villa The Lincoln.....	16	
Villa The Howick.....	18	
Bungalow The Pasadena	20	
Bungalow The Santa Monica + Garage	22	
Bungalow The Chico + Garage.....	24	
Cottage The Appleby.....	26	
Cottage The Ivy	28	
Character The Balmoral	30	4 Bedroom
Villa The Parnell.....	32	
Bungalow The San Deigo.....	34	
Bungalow The Fresno.....	36	
Bungalow The Laguna	38	
Character The Art Deco	40	5 Bedroom
Villa The Kingsland.....	42	
Villa The Fendalton	44	
Character The Kerikeri.....	46	
Character The Arundel.....	48	
The Glen Eden.....	50	
Double Garage.....	51	
Process.....	52	
Wishlist.....	53	
FAQ	54	

The Petite Avondale

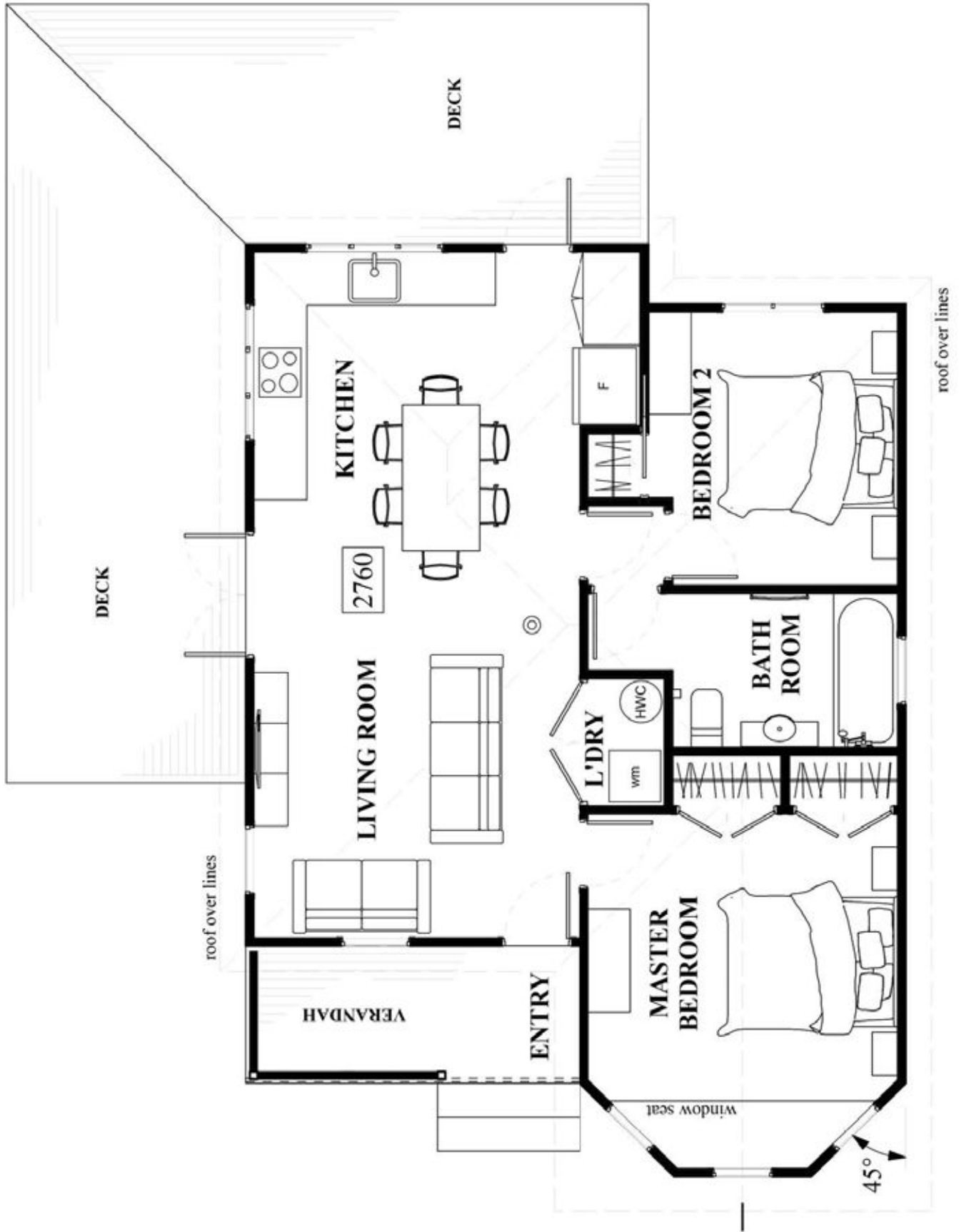



The Petite Avondale

Are you in love with the eye-catching Avondale home, but looking to downsize? Fear not, you can still live the dream. This Avondale is a 2 bedroom home perfect for a couple or small family. This home offers charm and elegance, from the warm entrance veranda to the angled single bay and detailed fretwork.



AREAS:

House	70.09m ²
Verandah	6.24m ²
Total.....	76.33m ²
Deck.....	38.64m ²

The Petite Newmarket

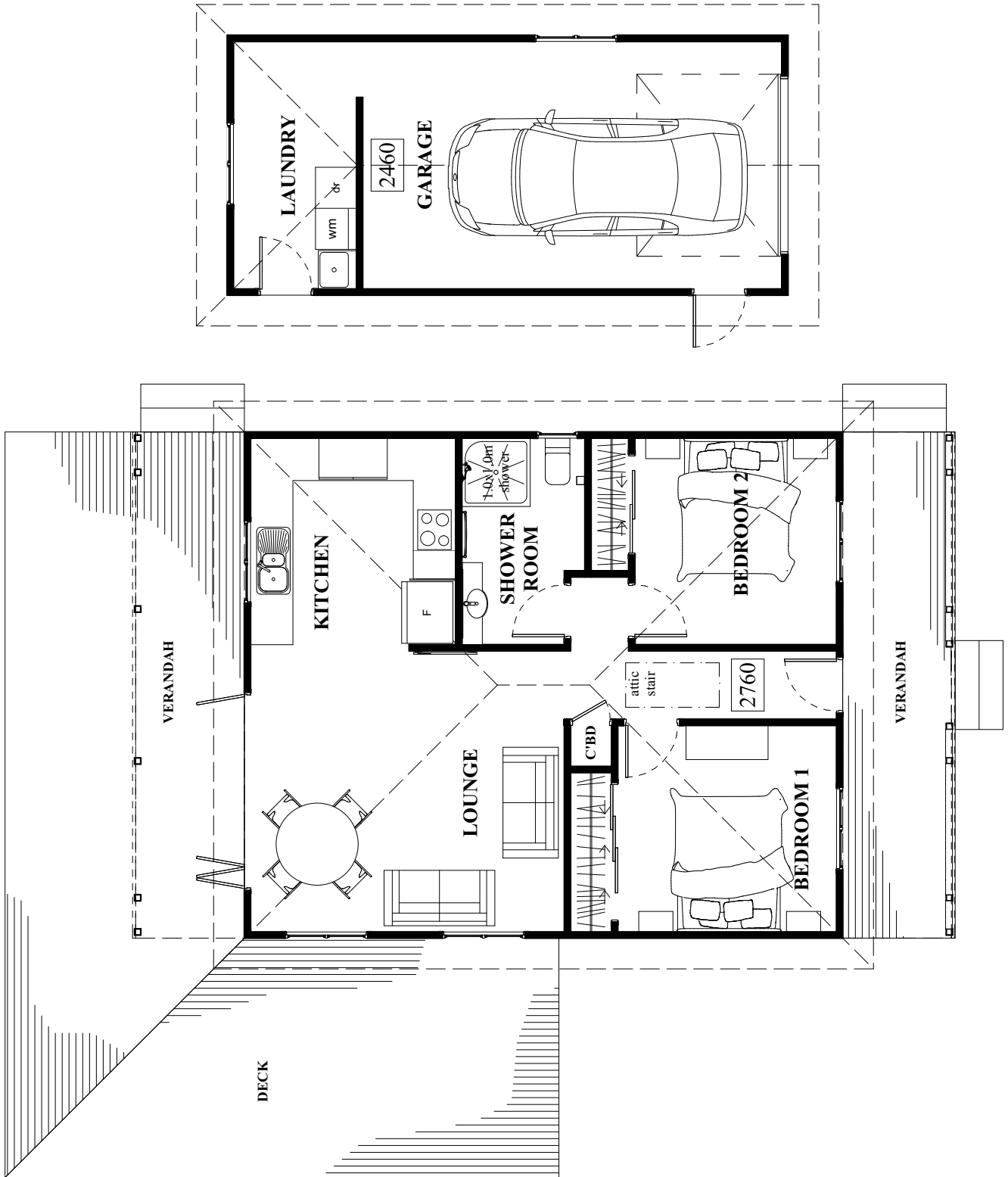



The Petite Newmarket

Do you love the look of the Newmarket, but are wanting a smaller home? You can still enjoy the modern look and luxurious style that the Newmarket offers. This 2 bedroom home offers open plan living to flow through the home and outside to the huge deck located off the lounge room.



AREAS:

House	64.75m ²
Garage	31.16m ²
Total.....	95.91m ²
Rear Deck.....	54.25m ²
Rear Verandah	12.17m ²
Front Verandah.....	12.17m ²



The Waipu

The Waipu is based on the early 1800's era. It is a stylish and comfortable 2-bedroom cottage. A truly delightful and compact pioneer home. Features range from a beautiful verandah entrance with a modest rear deck and corrugated iron gable end roof.

AREAS:

House	83.1m ²
Verandah	11.1m ²
Total	94.2m ²
Deck	14.1m ²

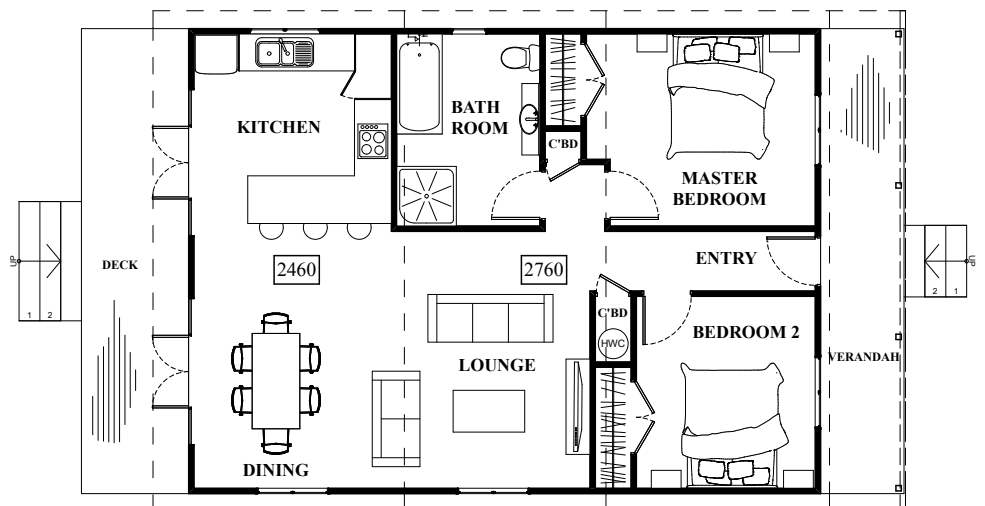



The Riverton

This elegant traditional early settler cottage is perfect for a small family or a couple. The front veranda provides a lovely entrance to greet your guests. Entertain on the beautiful rear deck which is perfect for gathering with your family.

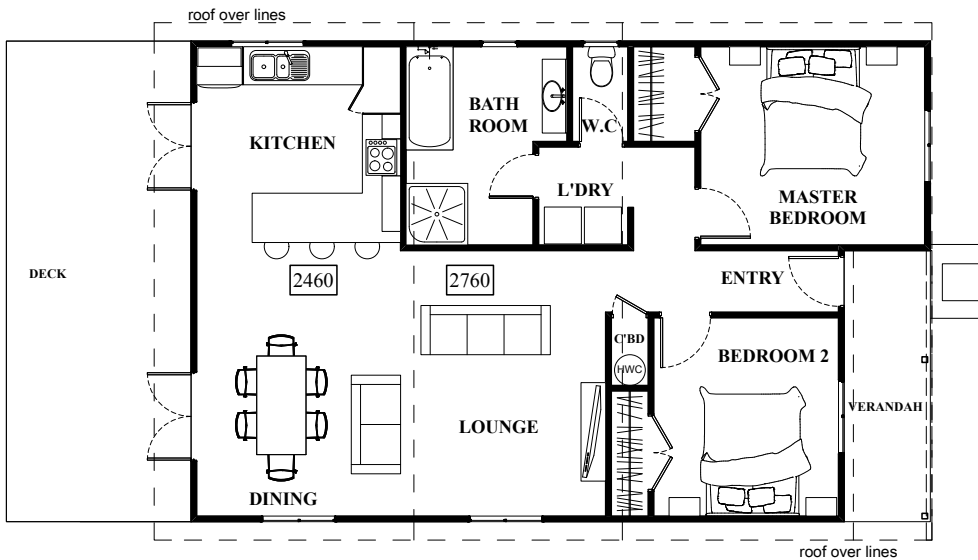

AREAS:

House	87.4m ²
Verandah	6.2m ²
Total	93.6m ²
Deck	23m ²





The Woodlands

Rustic brick, stone chimney and natural timber accents make this kiwi style cottage a classic. The wooden doors and window shutters give this home a unique and natural feel.

The Woodlands 2 bedroom cottage offers generous sized bedrooms, along with open kitchen and entertaining areas.

AREAS:

House	87.72m ²
Total	87.72m ²
Patio	21.50m ²

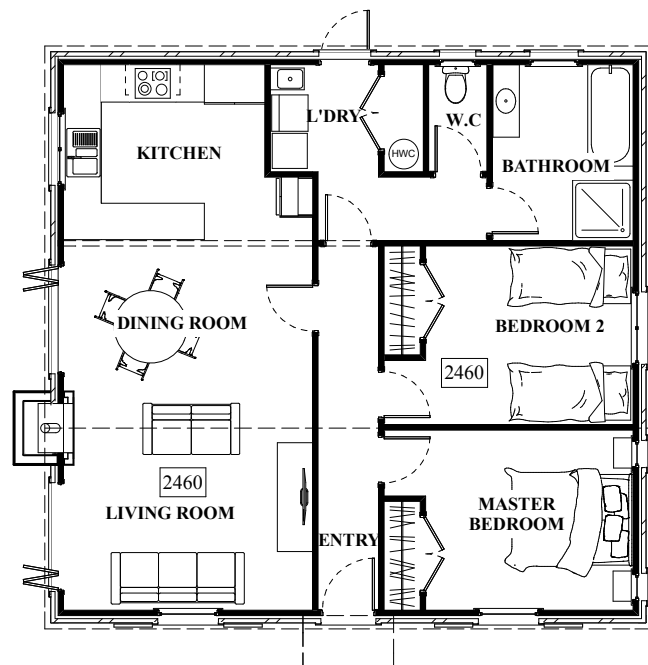



The Avondale

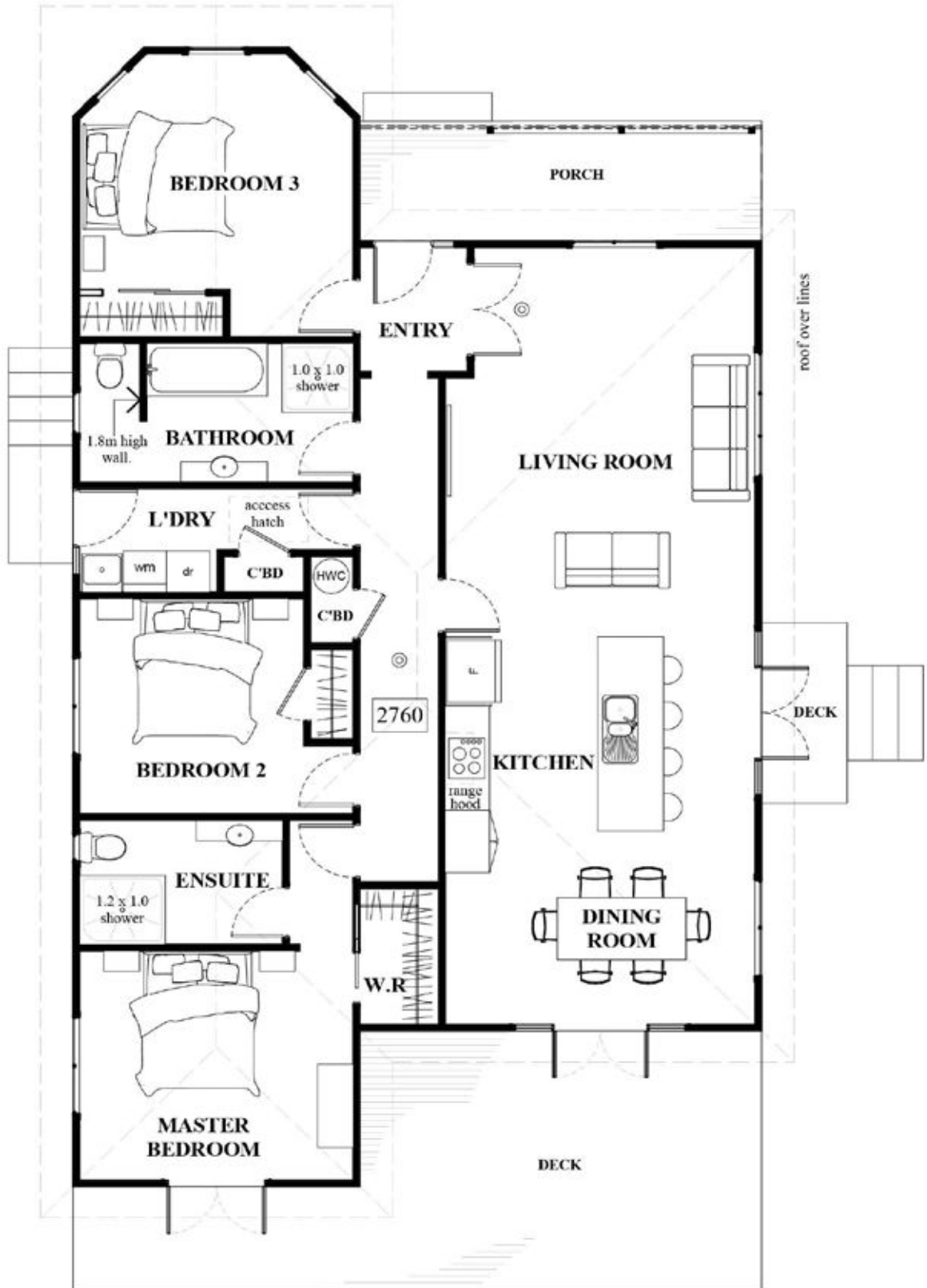



The Avondale

The Avondale is a timeless classic. The lattice and brackets decorate the graceful entry way to this early 1900's villa. The angled single bay provides a warm and inviting feeling surrounded by weatherboard cladding and corrugated long run roof. The Avondale offers 3 bedroom's comprising of 2 double rooms, a master suite with walk in wardrobe and ensuite. This home offers plenty of room for the family, as well as a large entertaining outdoor area, perfect for the summer BBQ.

AREAS:

House	128.54m ²
Verandah	9.72m ²
Total	138.26m ²
Deck	26.94m ²



The Bayswater

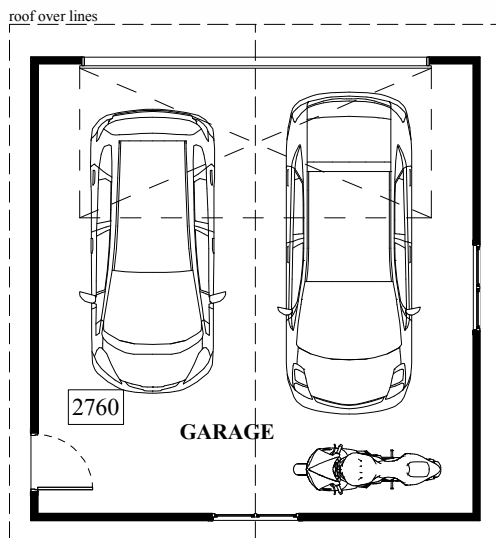
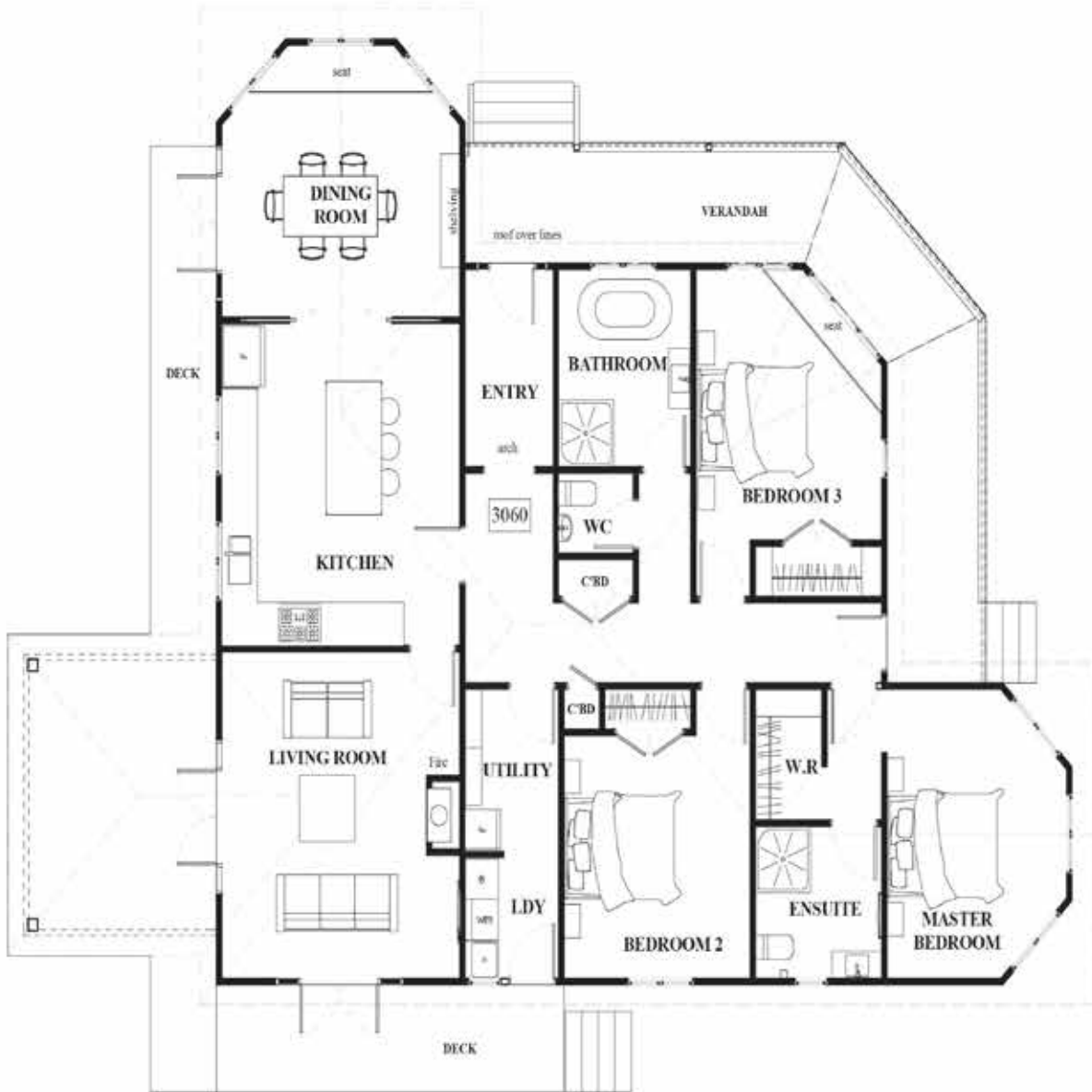

Love makes
a house
a home



The Bayswater

This gorgeous late 1800's corner villa provides stunning street appeal with a very generous sized entrance veranda. With 2 classic angle bays, and elegant roof lines. This home oozes charm. The grand entrance takes you down the hall into the extremely spacious kitchen with open plan living/dining room. This home offers 3 roomy bedrooms, including ensuite for the master, separate Laundry and utility plus a detached garage.

AREAS:

House	156.5m ²
Garage	40.00m ²
Total	196.54m ²
Deck	65.00m ²



The Newmarket + Garage



When there is Love
in the Home,
There is Joy
in the Heart





The Newmarket + Garage

The Newmarket villa has a luxurious feel, from the beautiful elegant lattice detailing on the front veranda to the well thought out open plan living with indoor/outdoor flow, perfect for your summer entertaining. This charming and modern 3-bedroom home has a clean graceful appearance with the added advantage of an ensuite in the master bedroom. Head through the laundry for internal access to your 2-car garage.

AREAS:

House 119.05m²
 Garage 42.51m²
 Total 161.56m²

Verandahs 16.06m²
 Decks 16.50m²



The Lincoln

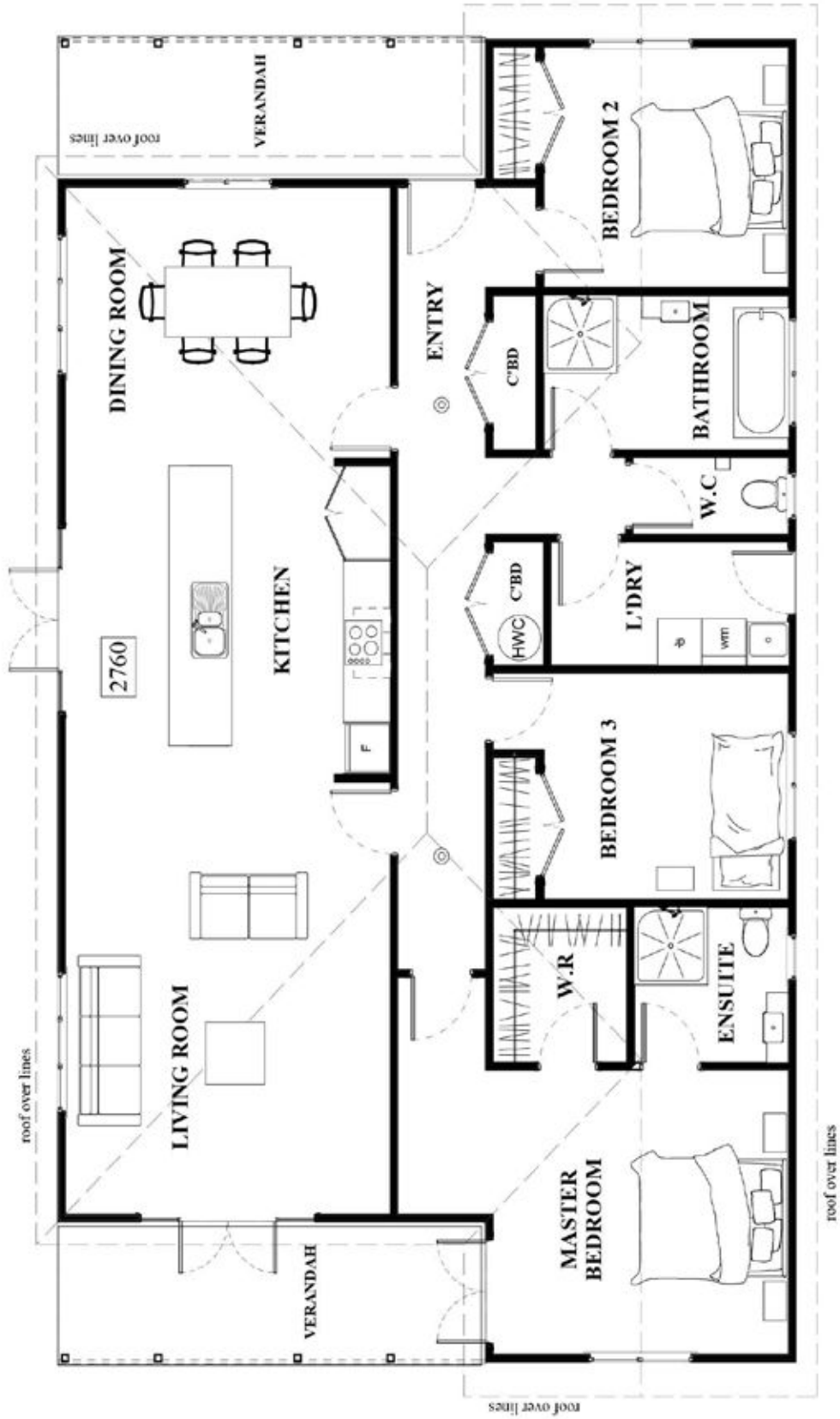



The Lincoln

With its late 1800's design influence, The Lincoln features a single decorative bay with a front veranda and simple fret work. Three generous sized bedrooms are accessed through a grand hallway. The open plan living spaces make the most of the double verandahs.

AREAS:

House	149.12m ²
Verandah	32.1m ²
Total	181.22m ²





*Home is where love resides,
Memories are created,
Friends and Family belong
and laughter never ends*





The Howick

The Howick is our elegant turn of the century villa. The eve brackets are completed with finials. The living spaces make great use of the double verandahs while the 3 spacious bedrooms and internal garage access make way for modern living.

AREAS:

House	149.12m ²
Garage	41.04m ²
Total	190.16m ²
Deck	11.47m ²
Verandah	19.38m ²



The Pasadena

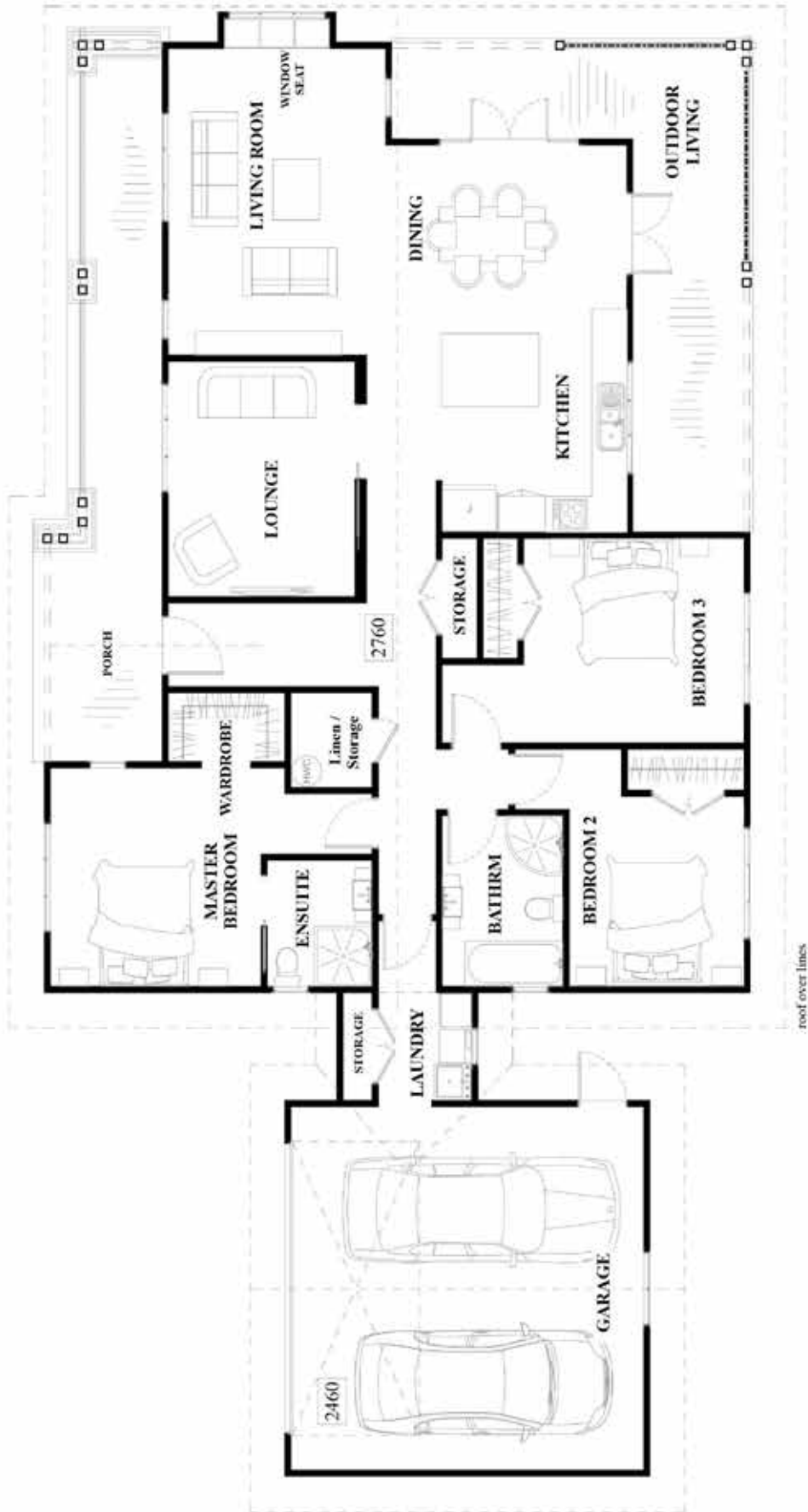



The Pasadena

The Pasadena is one of our most popular bungalows known for its 1930's style. Complete with the shingle roof, dual sized weatherboard features and stylish roof vent. The interior is equally as pleasing with open plan living for both formal and casual spaces. The design allows for indoor outdoor flow through large opening doors off the dining area, wide windows and a square lay window setting. The 3 large bedrooms, separate lounge and living space allows plenty of room for a growing family. The back L shaped deck is a perfect location to sit, relax and enjoy the sun.

AREAS:

House	147.1m ²
Garage	38.4m ²
Total	185.5m ²
Front Verandah.	22m ²
Rear Verandah	24m ²
Total	46m ²



The Santa Monica + Garage

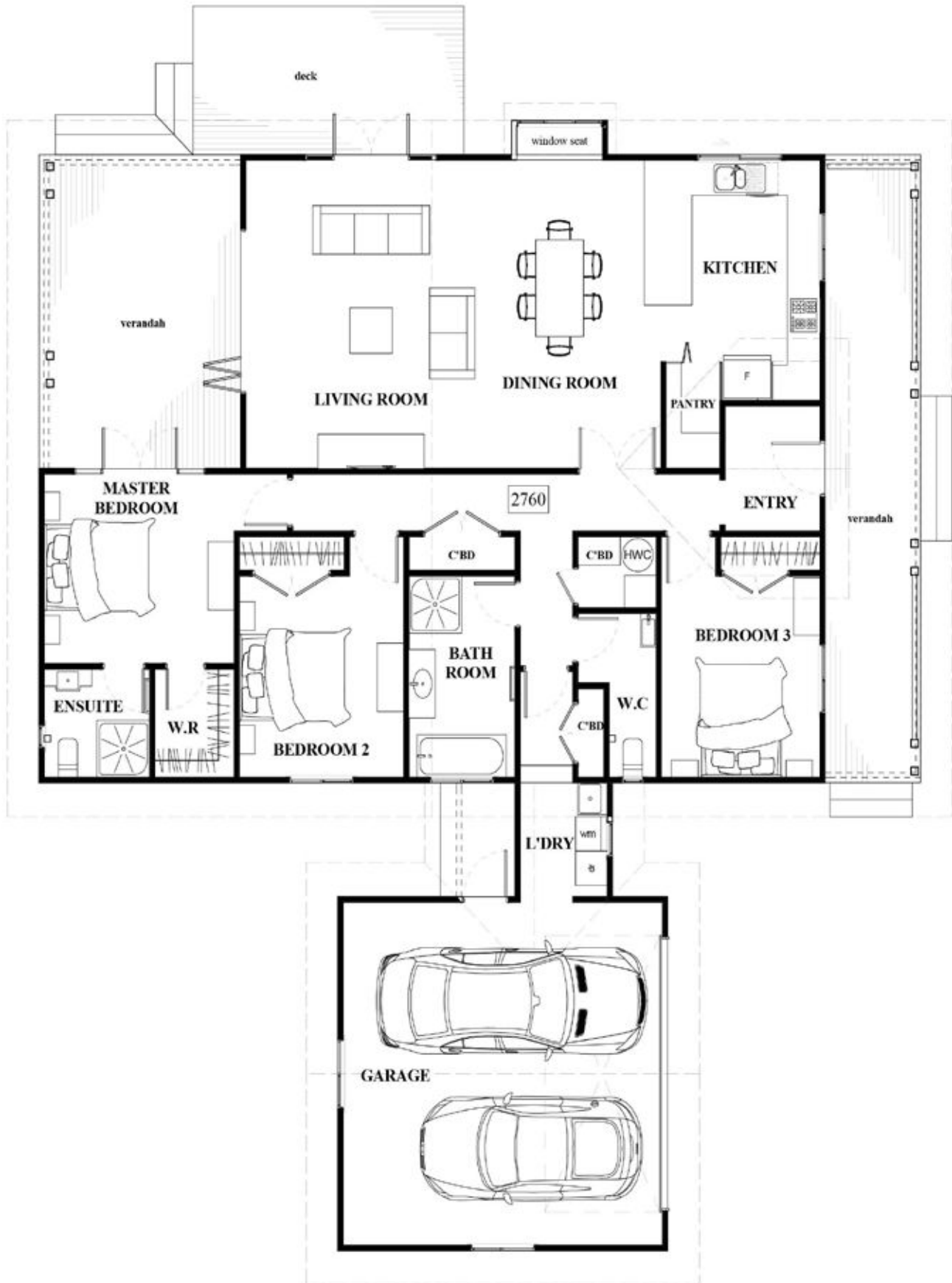



The Santa Monica + Garage

This home is everything you have dreamed of and more. The decorative gable, square pillars and verandah entry will make you fall in love with this home. Chase the sun all day with the option of entertaining on one of the three decks located around the home, one of which is a large covered deck which is perfect for a family BBQ.

Having someone to Love is a Family,
having somewhere to go is a Home

AREAS:

House	142.98m ²
Garage	42.10m ²
Total	185.08m ²
Entry Verandah	19.80m ²
Outdoor Living Covered... ..	20.90m ²
Deck	13.26m ²



The Chico + Garage

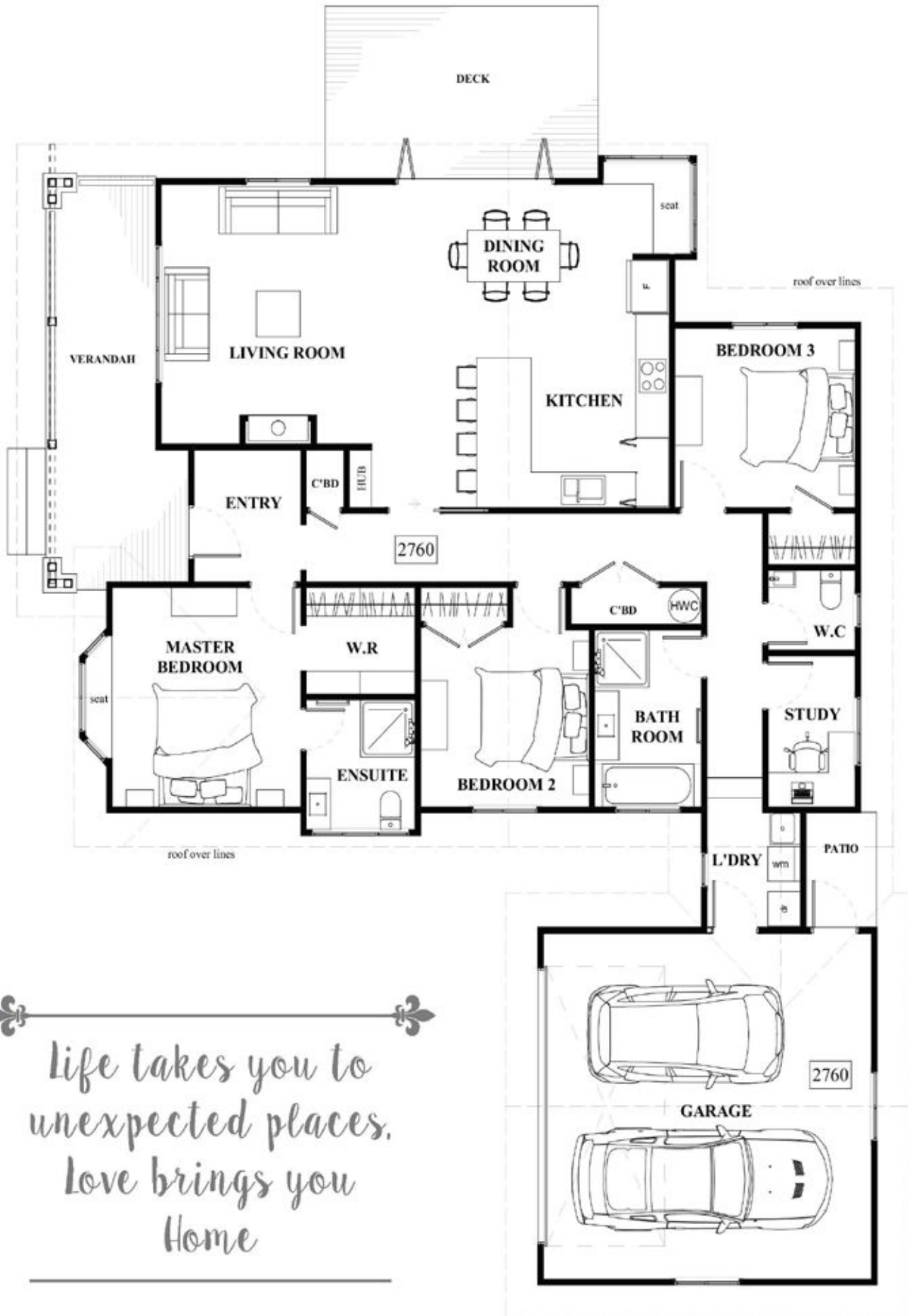

Life takes you to unexpected places.
Love brings you Home



The Chico + Garage

The Chico is designed to make the most of space with its clever floor plan. There is plenty of storage throughout the house, featuring a sun nook in the living area and a warm fireplace where you can cosy up on those cold winter nights. This home also offers the added advantage of an internal access double garage.

AREAS:

House	138.10m ²
Garage + Laundry ...	42.86m ²
Total.....	180.96m ²
Verandah	15.92m ²
Deck.....	15.00m ²



The Appleyby

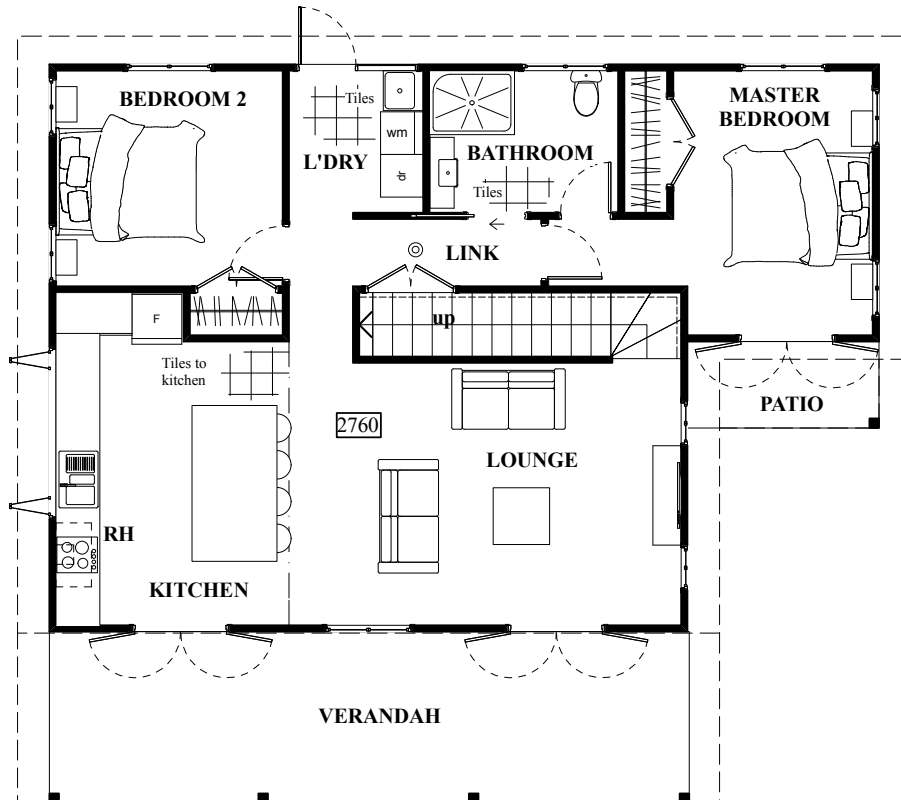
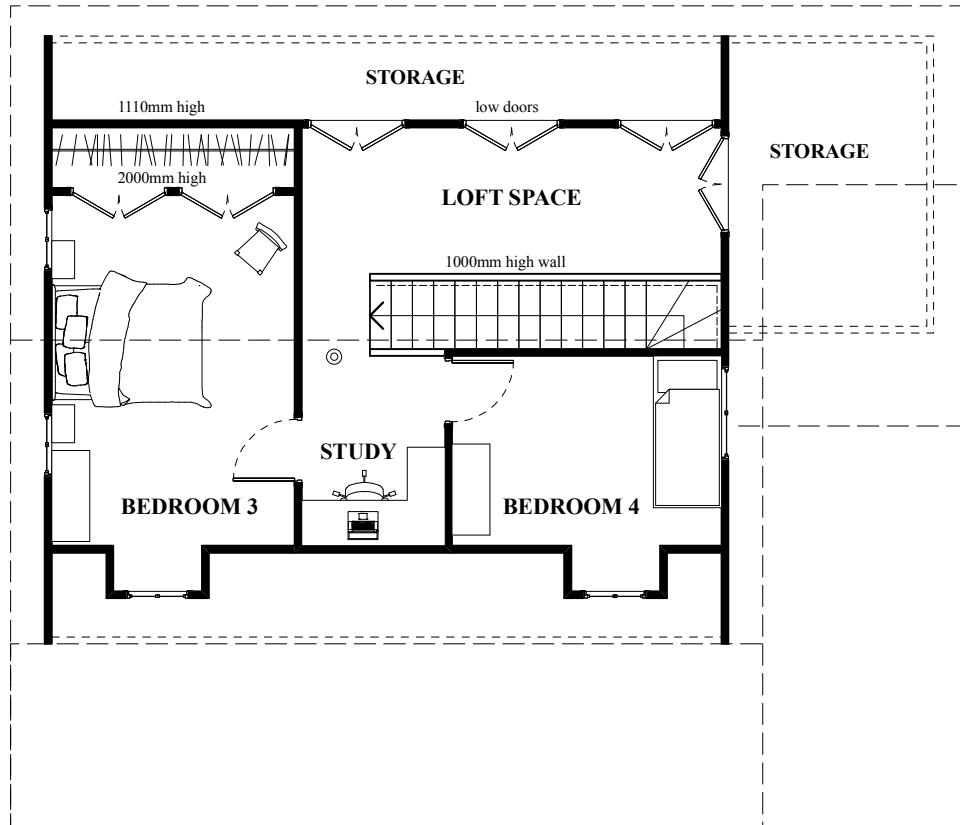



The Appleby

Gabled Dormer windows in the roofline peek out over the view of your choice in this quaint 3 bedroom home with study and loft. You'll love the charming and characteristic french doors that look out upon the stylish covered veranda with its square posts and decorative trim.

AREAS:

Ground Floor 82.56m²
 First Floor 73.38m²
 Total 155.94m²

Verandah 21.78m²
 Patio 3.29m²



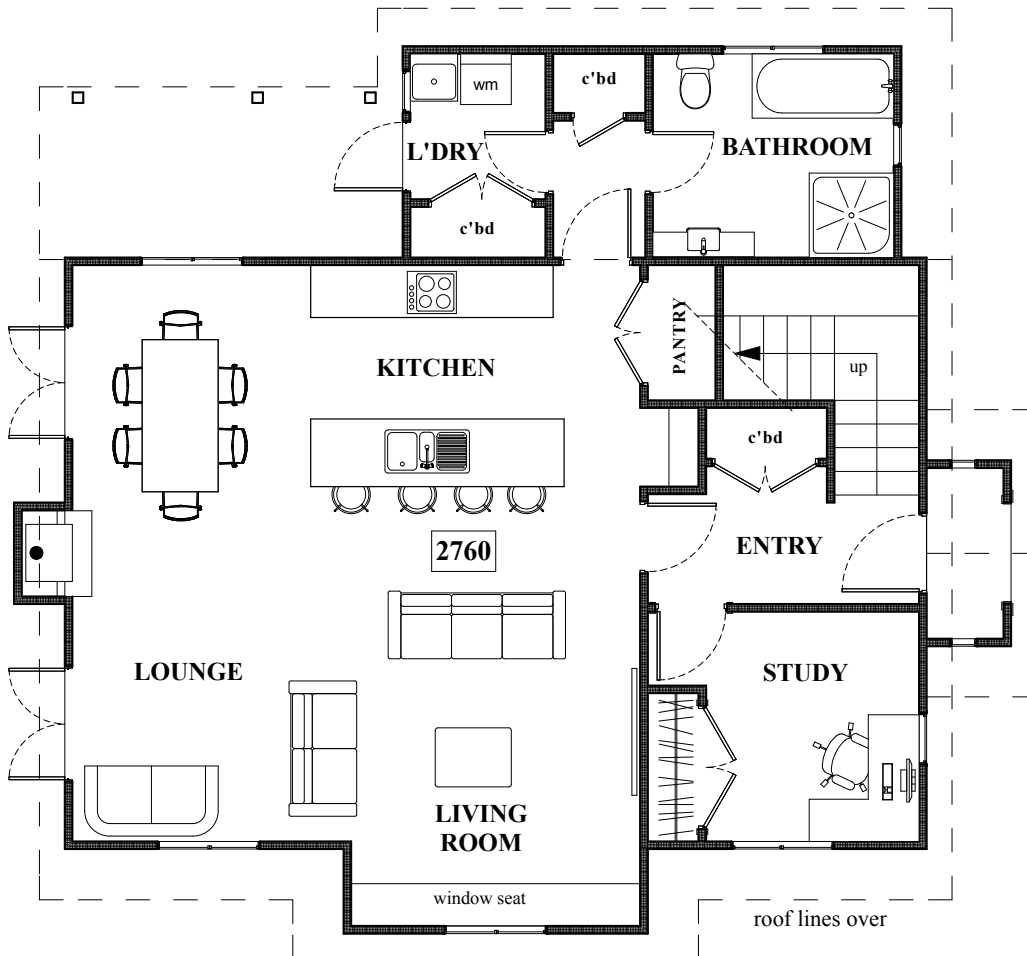
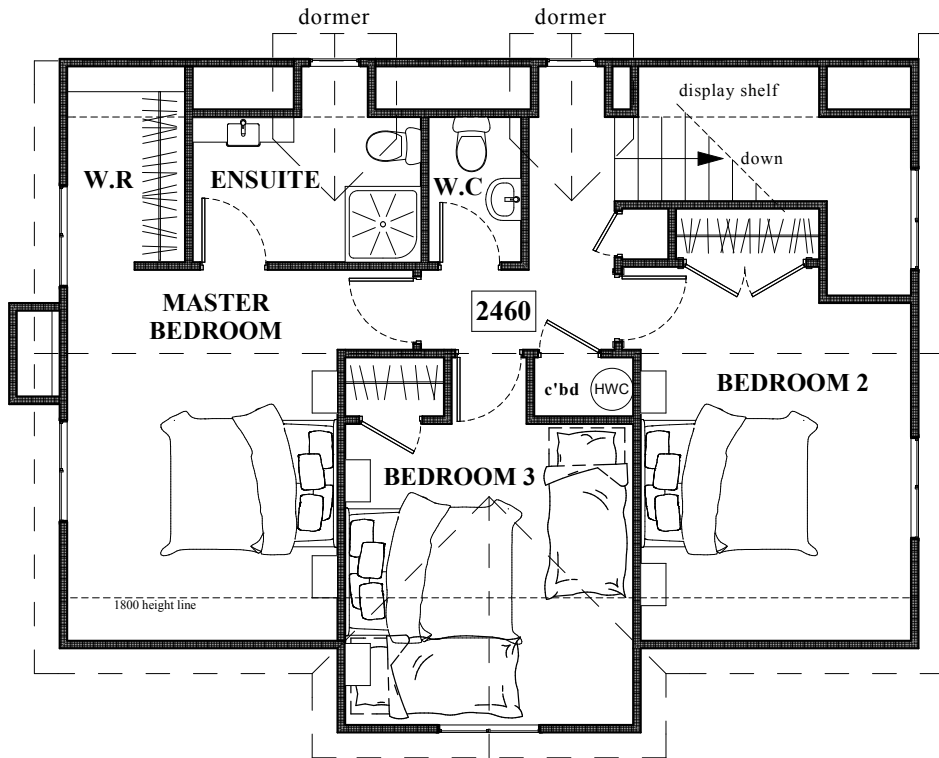

AREAS:

Ground Floor.....	92.67m ²
First Floor.....	75.00m ²
Total.....	167.67m ²



The Ivy

Our 1930s inspired cottage consists of weatherboard and stacked rock set against its steeply pitched roofline. It utilises two floors to reduce site footprint without losing the grandeur of its time. The traditional porch entry, stone chimney and boxed corner seat are charming yet meaningful features in this spacious open plan two storey home.

AREAS:

Ground Floor 92.67m²
 First Floor 75.00m²
 Total 167.67m²



The Balmoral

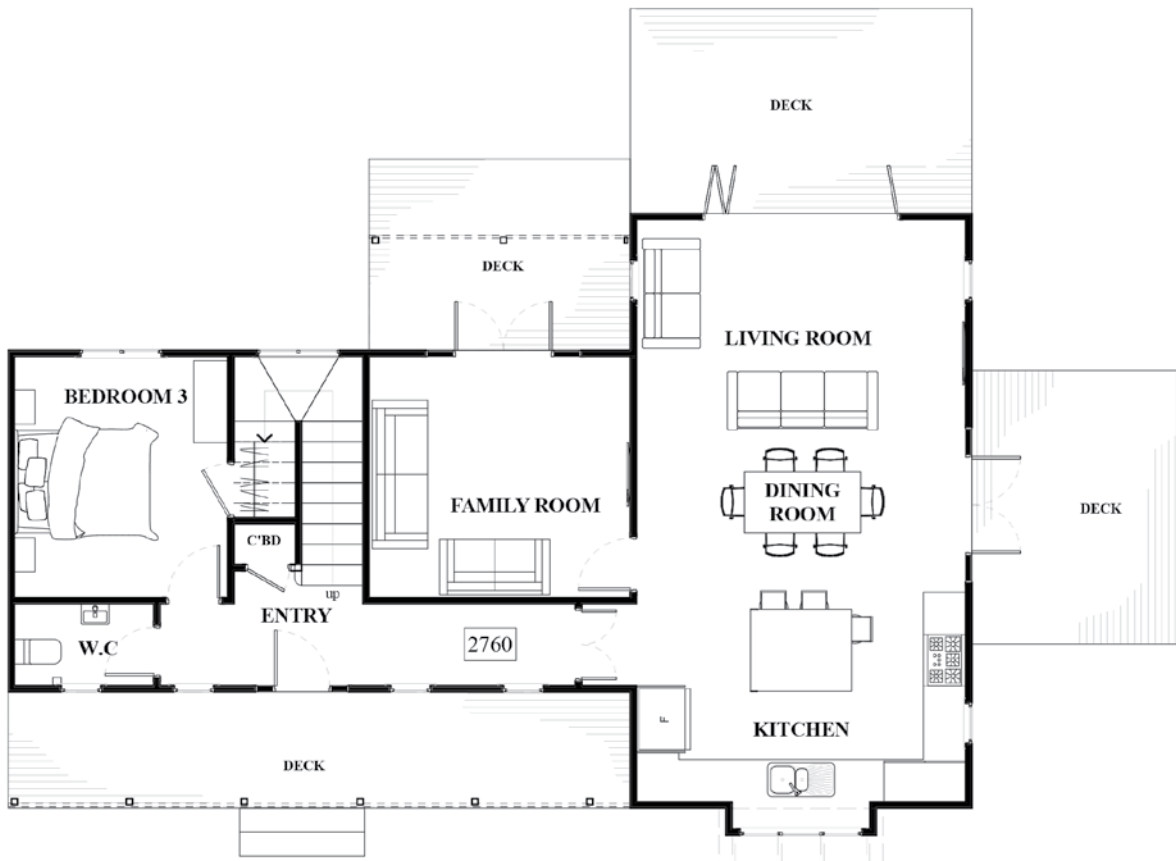
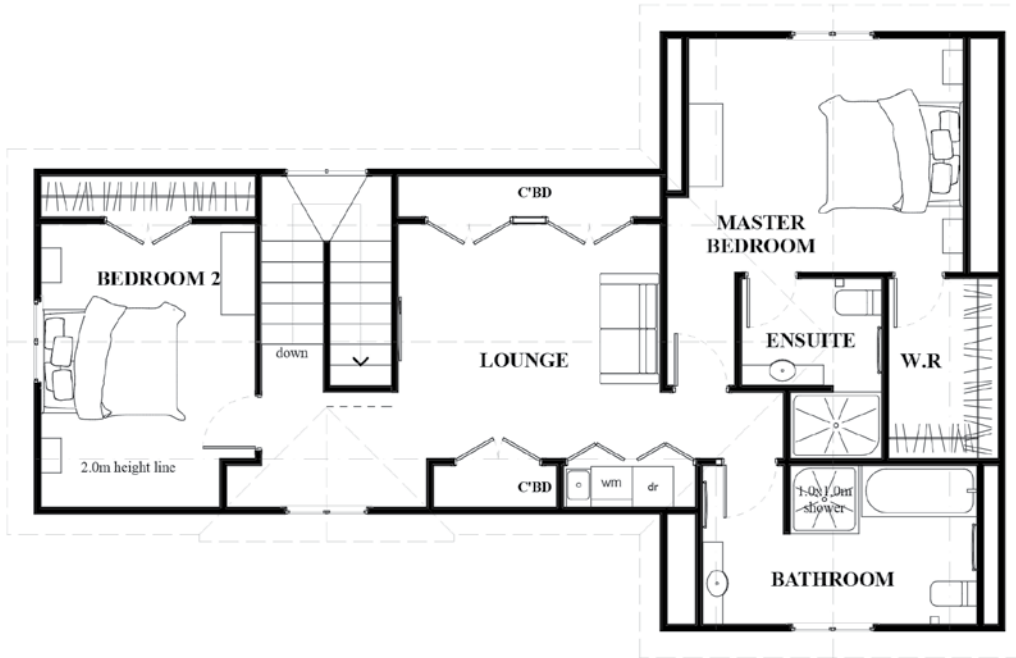



The Balmoral

Suiting a variety of landscapes, The Balmoral home is classically beautiful with quoin options on each external corner, decorative gables, and classic fretwork, tying it altogether and really completing this home. The footprint is perfect for smaller plots or sections, yet you will find this home to be extremely spacious. With 3 generous bedrooms across two floors and two living areas, this home has plenty of space for everyone. The Balmoral was designed with specific attention to storage space.

AREAS:

- Ground Floor89.88m²
- First Floor89.88m²
- Total179.76m²
- Verandah22.1m²





*Distance has no meaning
The Heart always finds
its way home*





The Parnell

The Parnell's beautiful cladding complements the lacework and brackets on the front verandah, which makes this home a favourite. The corrugated long run roof comes together over decorative gables, and the featured square bay window brings it all together, making for a welcoming home. The Parnell is a delightful larger family home, perfect for bringing everyone together in the spacious living areas.

Do you love the Parnell but want more of the 1800's style exterior? This villa also comes in a design utilising brick work.

AREAS:

House 177.52m²
 Garage 45.53m²
 Total 223.05m²

Verandahs 18.56m²
 Decks 54.14m²



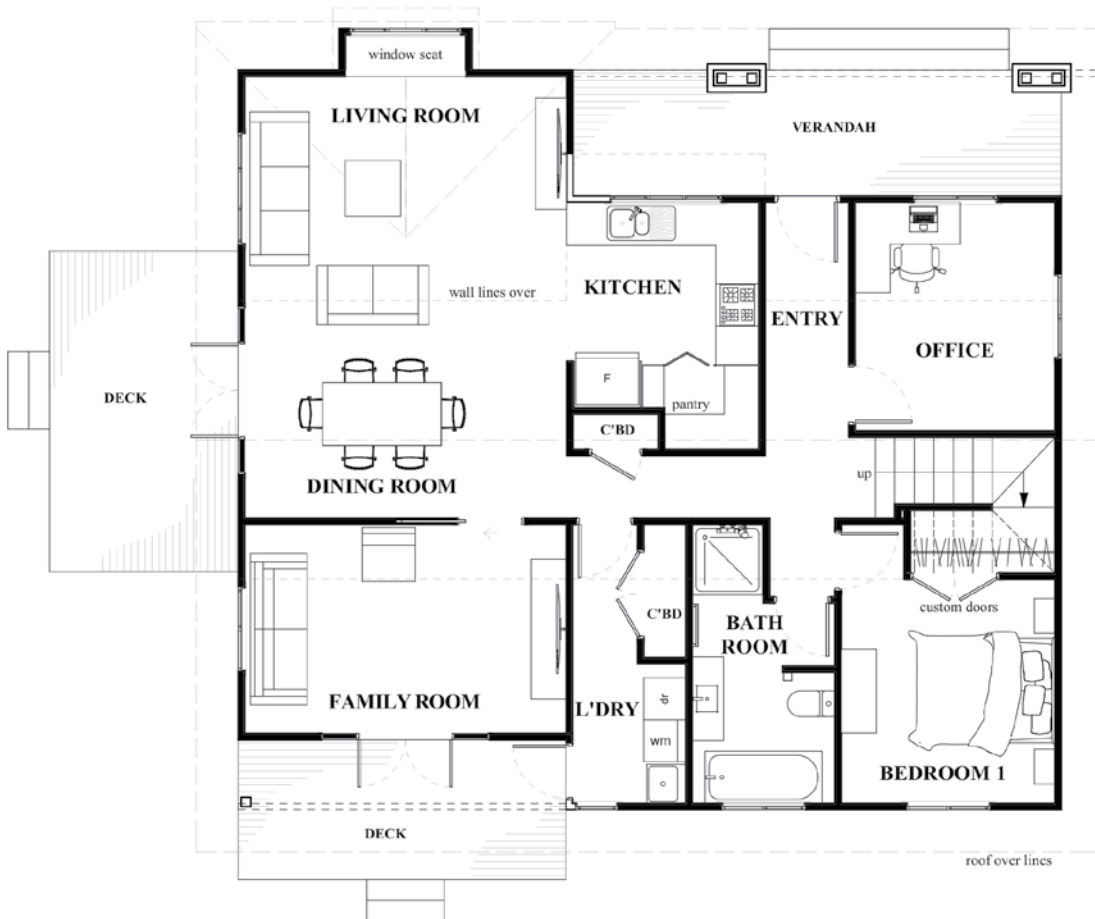
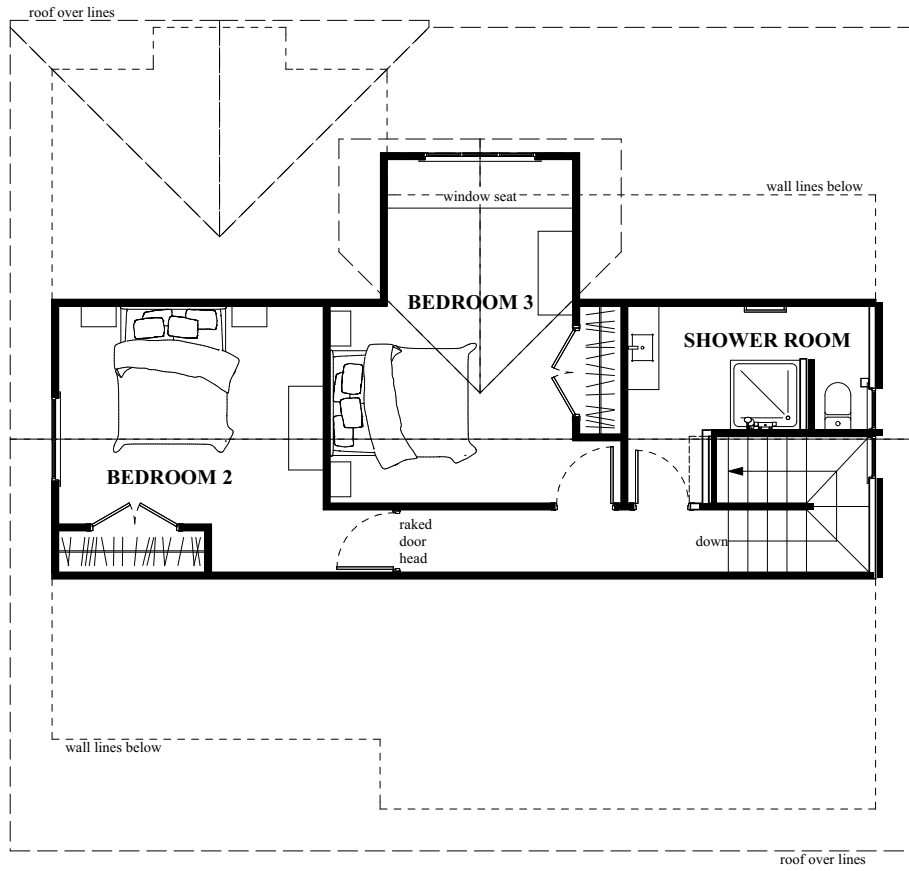



The San Diego

Compact and clever, The San Diego home is unimposing and hides 2 storeys filled with 4 bedrooms, two living areas, a verandah and two decks and is completed with a well-proportioned kitchen and plenty of storage. This home offers a variety of indoor/ outdoor flow. Clad in weatherboard with square pillars and a box window seat, this home offers a classic style.

AREAS:

Ground Floor 108.92m²
 First Floor 53.17m²
 Total 162.09m²

Entry Verandah 12.59m²
 Rear Verandah 4.70m²
 Dining Deck 12.42m²
 Family Room Deck 9.40m²



The Fresno

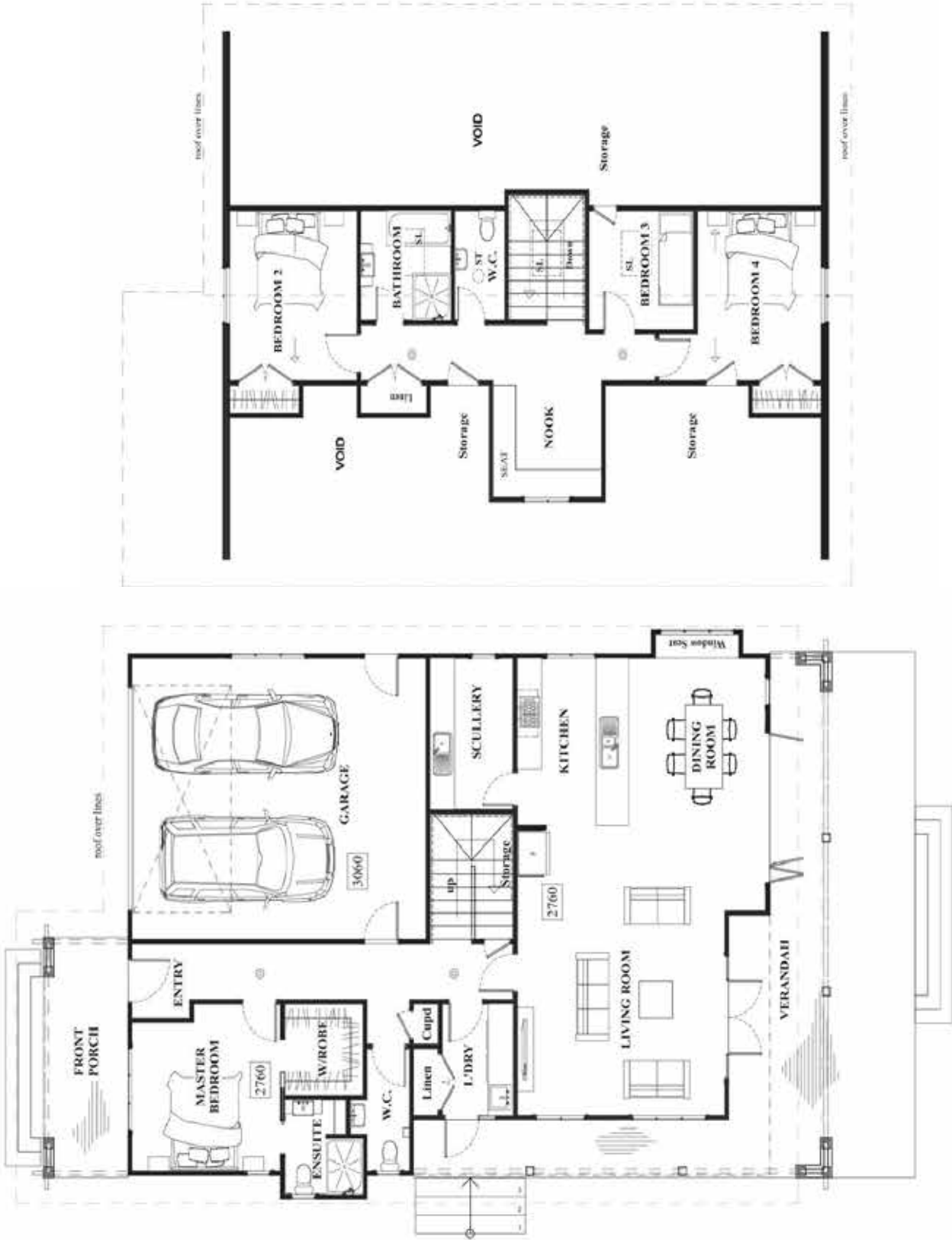

Love begins at home



The Fresno

This delightful 2 storey home is everything you want and more. It features all the delights of a modern family with a large kitchen and butler’s pantry, internal access garage, and spacious bedrooms providing plenty of area for a growing family. The gorgeous wrap around deck provides added living space for easy entertaining.

AREAS:

Ground Floor.....116m²
 First Floor..... 73m²
 Garage 45m²
 Total.....234m²

Decks.....10.5m²
 Verandahs 65.1m²



The Laguna

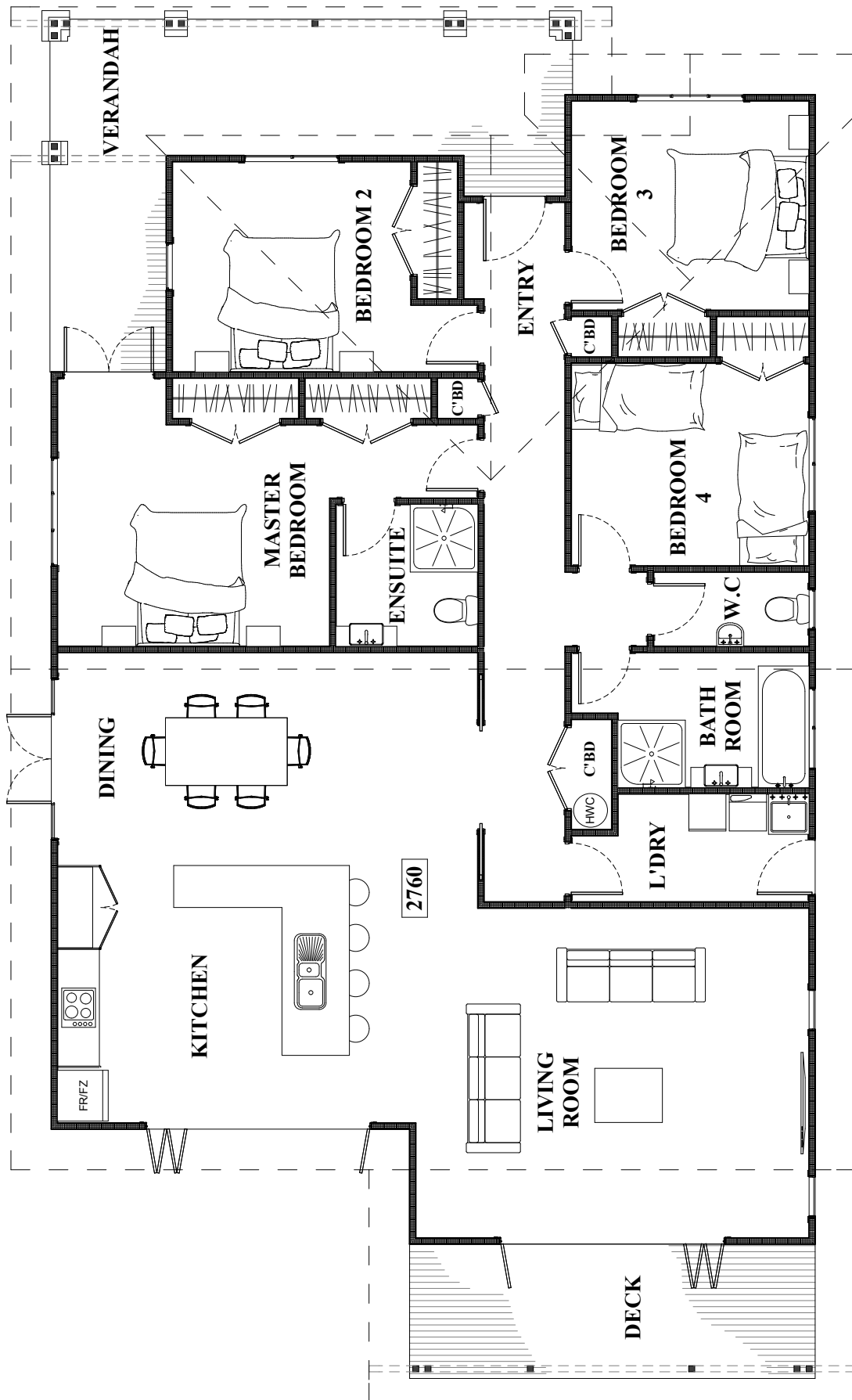



The Laguna

The Laguna is a beautiful bungalow with 4 large bedrooms, separate laundry and open plan living spaces. This home is perfect for a growing family.

AREAS:

House	170.00m ²
Total	170.00m ²
Verandah	22m ²
Deck	12m ²



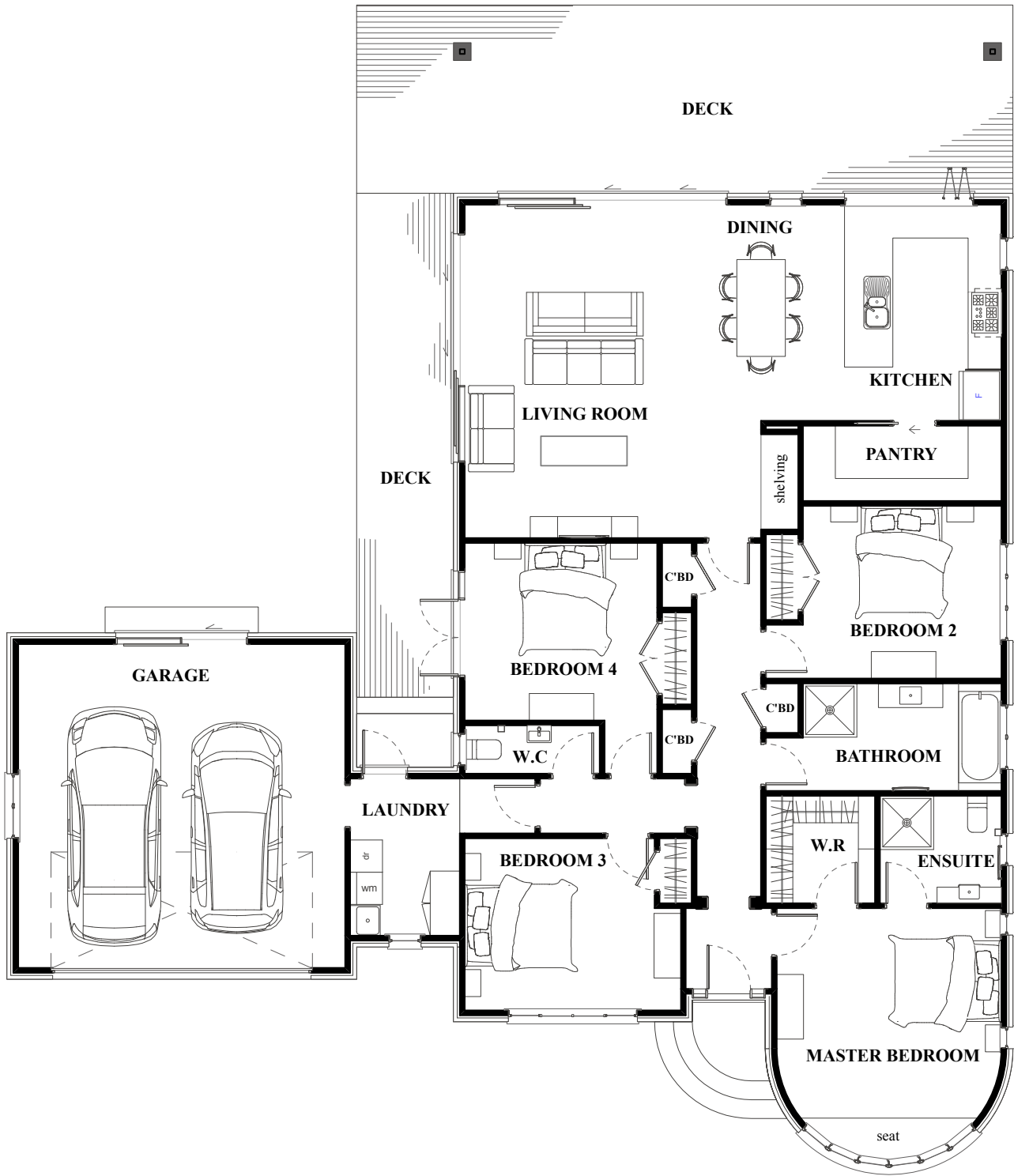

Love builds a happy home



The Art Deco home is the most unique home of them all, keeping in true 1910-1940 modernism, this iconic style is on the comeback. From the rounded entry stairs to the half-rounded bay, this home shows a point of difference to all the others. The inside is also very dazzling with 4 spacious bedrooms, 2 bathrooms, and a large open plan kitchen/dining area that flows onto a generous size deck wrapping right around the back of the house. The internal access double garage is convenient on those rainy days.

AREAS:

House	169.83m ²
Garage	48.27m ²
Deck.....	61.91m ²
Total.....	280.01m ²



The Kingsland

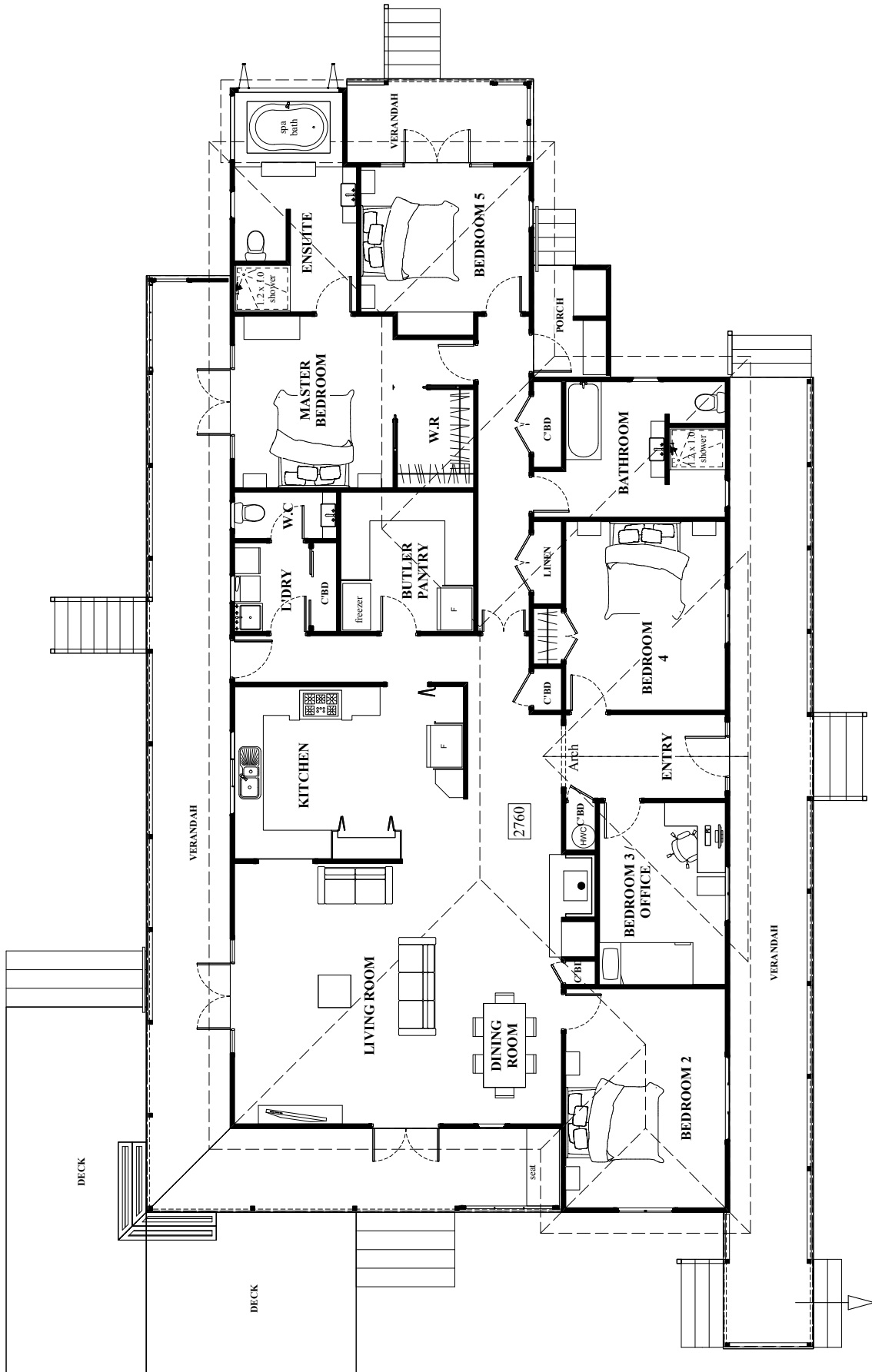



The Kingsland

With such grand street appeal and an inviting entrance way, this home is sure to delight all who gaze upon it. Taking its inspiration from the 1880's, the Kingsland home reflects the best of the era. Featuring post brackets and column mouldings on the front veranda as well as eve brackets and finial. From the dazzling entrance, to the internal living spaces, you are sure to fall in love with this home. This large home offers plenty of space, including the luxury of a walk-in pantry and the charm of a fireplace for the cooler evenings.



*Our Home is the Story of Who we are
and a collection of all the things we Love*

AREAS:

House	212.65m ²
Total	212.65m ²
Deck	46.43m ²
Front Verandah	37.89m ²
North Verandah	48.92m ²
Porch Verandah	3.96m ²
East Verandah	7.20m ²



The Fendalton

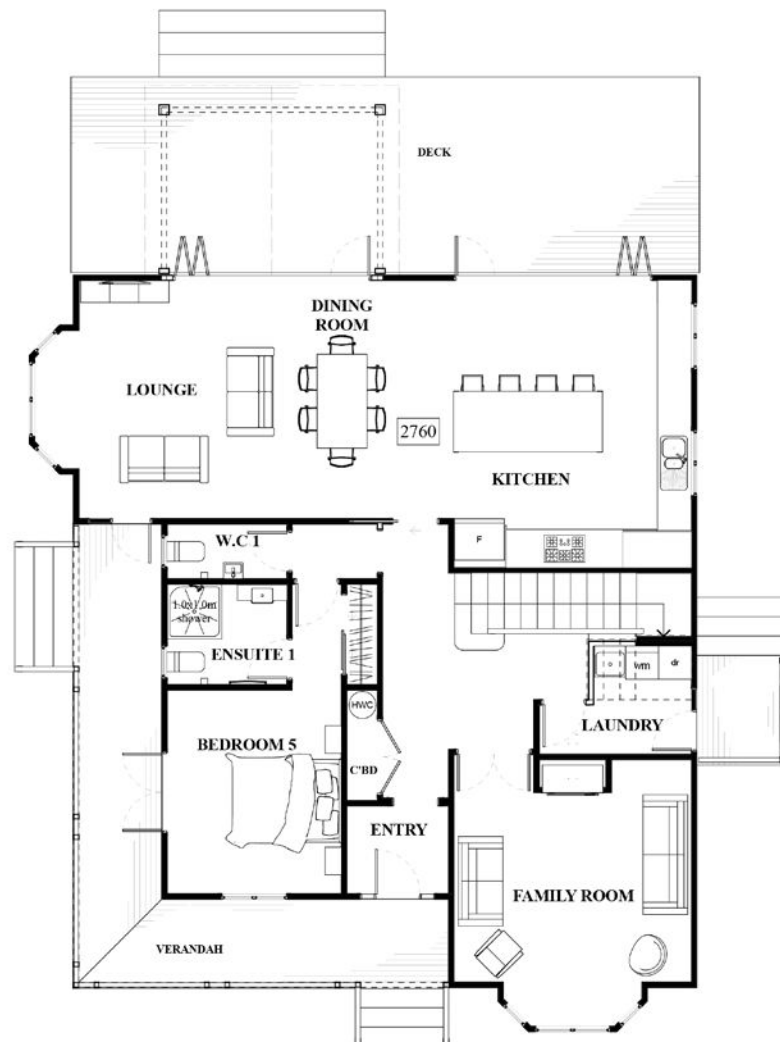
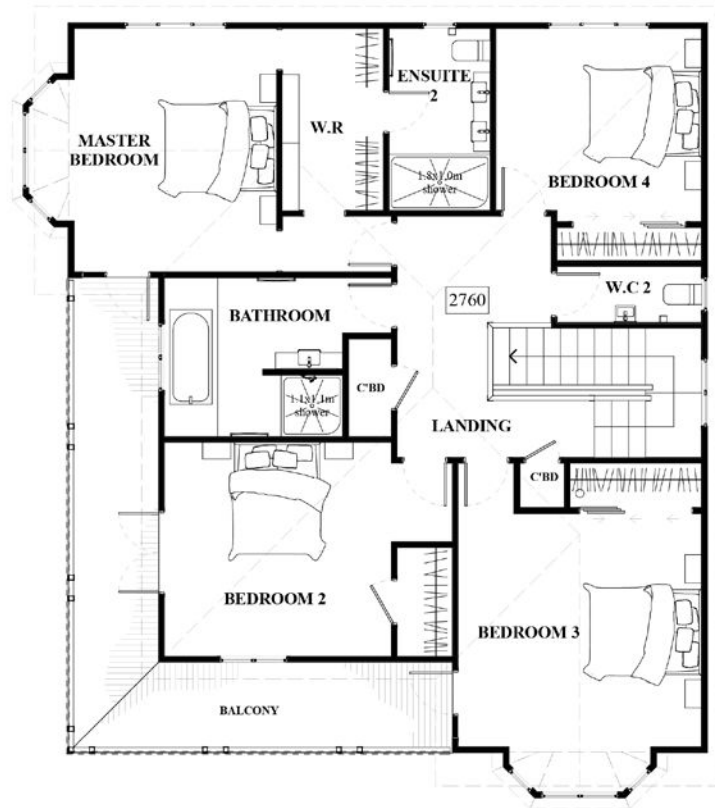



The Fendalton

Old school elegance is the key to the design inspiration of this early century two-storey villa. Angled bays provide added appeal to the exterior as well as generous size wrap around verandahs on both levels. The master suite on the first floor is sure to please with its clever wardrobe design and oversized shower in the ensuite. The flow from the living areas to the very lavish deck will make entertaining a breeze.

AREAS:

Ground Floor.....	127.73m ²
First Floor.....	127.73m ²
Total.....	255.46m ²
Verandah.....	21.76m ²
Balacony.....	21.76m ²
North Deck.....	40.47m ²
Roof Over Deck.....	12.53m ²





The Kerikeri

This traditional missionary styled home features a wrap around verandah, 5 double bedrooms, a generous master suite with walk in wardrobe and 3 bathrooms. This home has it all. Including a grand staircase upon entry into the home, and a substantial living area, you have plenty of room for a large family. The arched windows bring an elegant wow factor to the home embracing a rich heritage look.

*What I Love most about my Home
is the people inside*

AREAS:

- Ground Floor112.86m²
- First Floor.....112.86m²
- Total225.72m²

- Verandah101.20m²



The Arundel

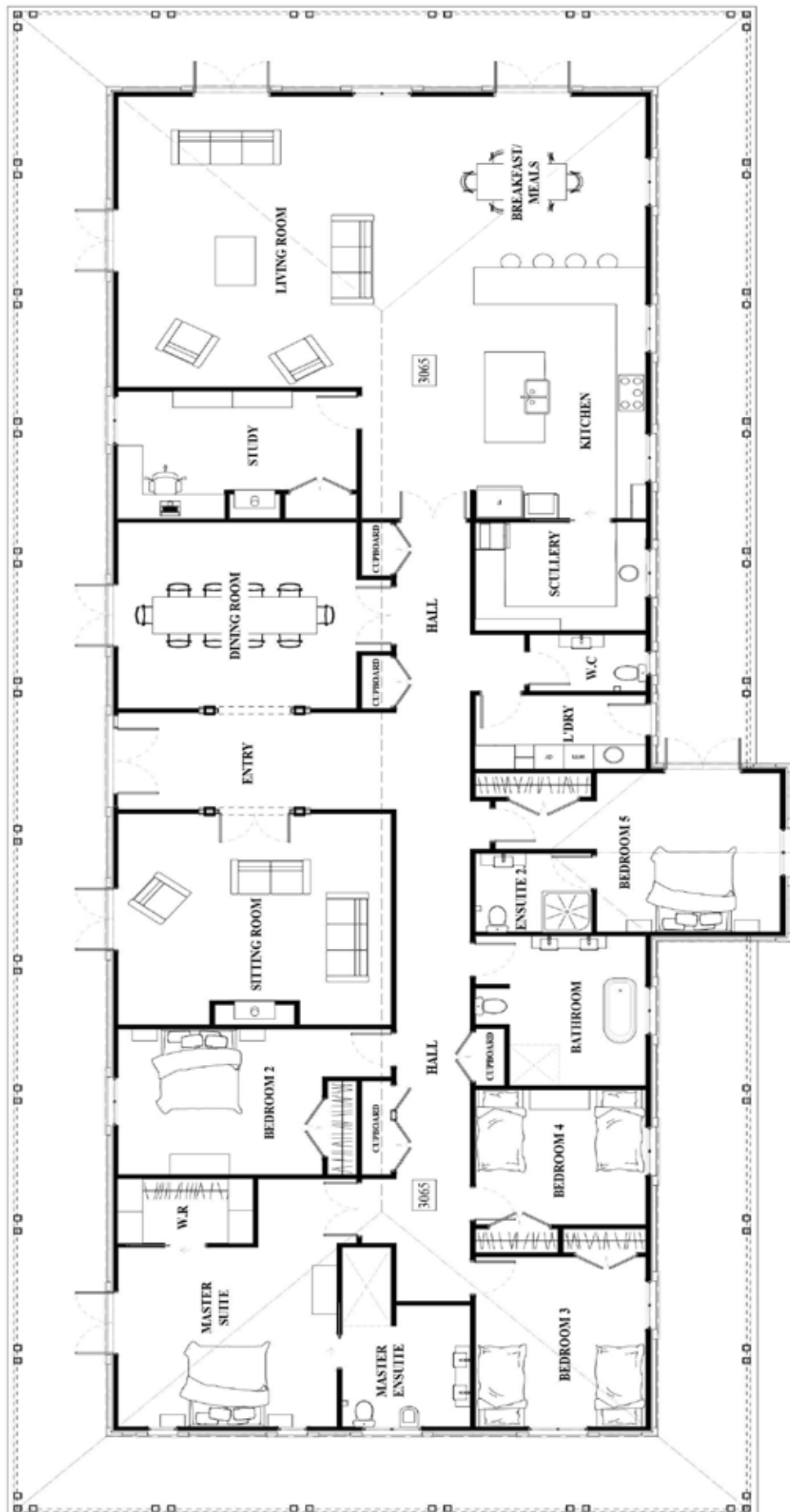



The Arundel

This beautiful late 1800's design, The Arundel is the largest heritage home in our range. The stunning vintage French doors and wide windows open out onto the wrap around veranda from all sides. It has two living areas and separate formal dining room, kitchen complete with butler's pantry and an abundance of storage. The Arundel was designed with entertainers in mind. The five bedrooms are spacious, including the guest room, offering space for everyone. It has two ensuites, a family bathroom and a powder room, as well as a study/office. This home is a very low maintenance option and has everything you need and more.

AREAS:

House	378.71m ²
Total	378.71m ²
Verandah	172.45m ²



The Glen eden



The Glen Eden

The Glen Eden is designed to give a Garage and a Loft. Complete with a bathroom it becomes the ideal studio, sleep-out or rumpus room. Timber weatherboards, boxed corners and a feature finial, with the addition of a Romeo balcony at the rear, adds to the overall character.

AREAS:

Upper Floor	42.00m ²
Garage	42.00m ²
Total	84.00m ²
Balcony	2.68m ²

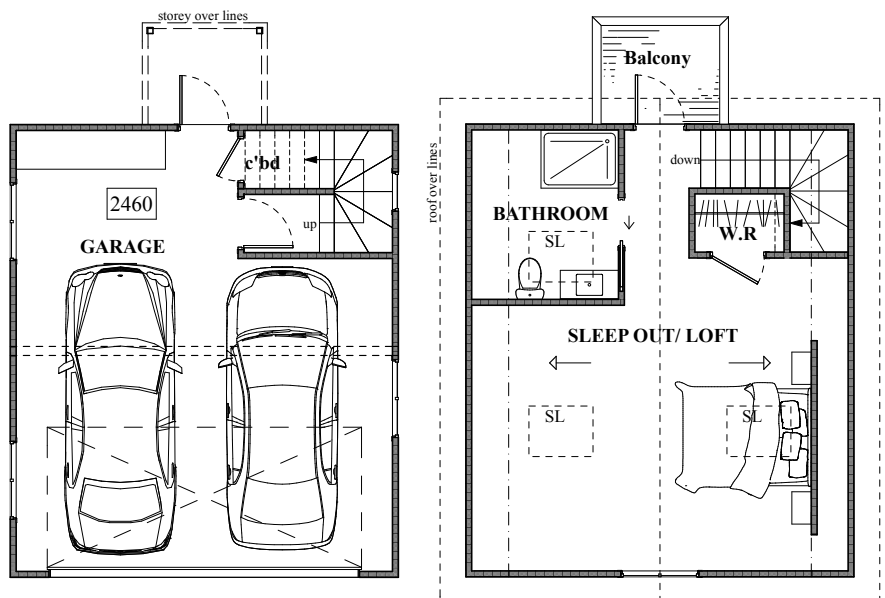

Garage - Double

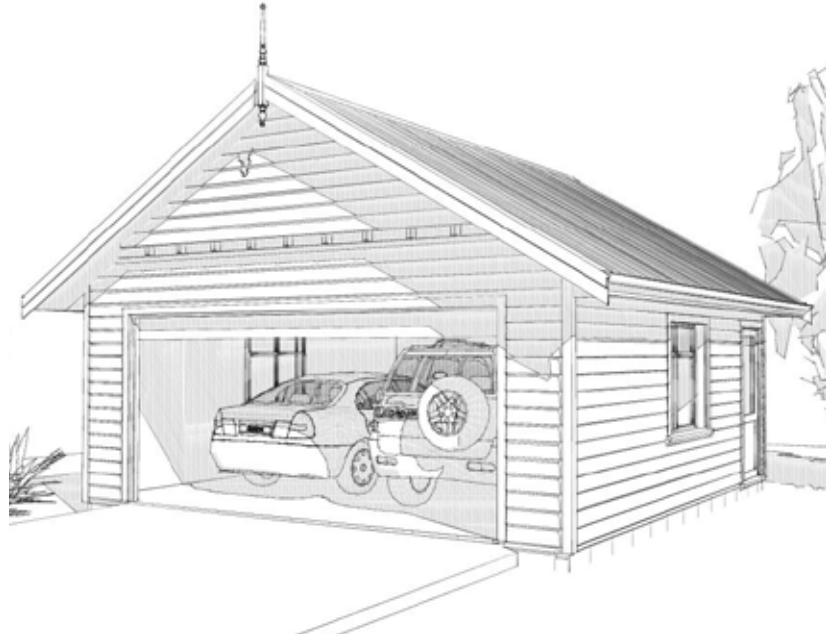
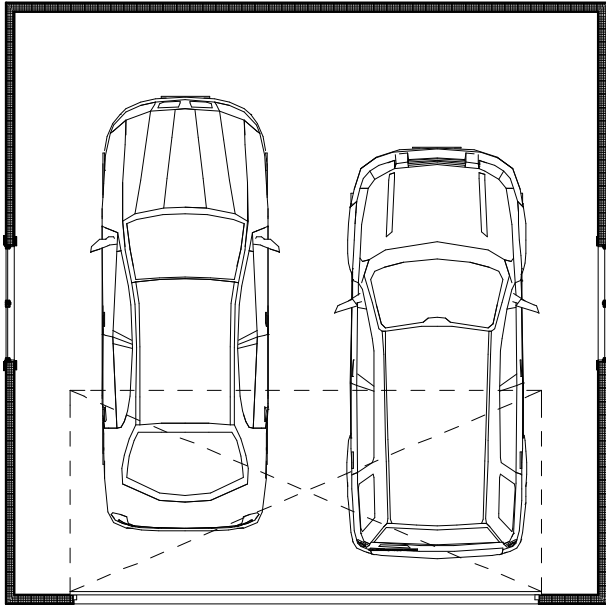

AREA:

Double Garage 38.51m²

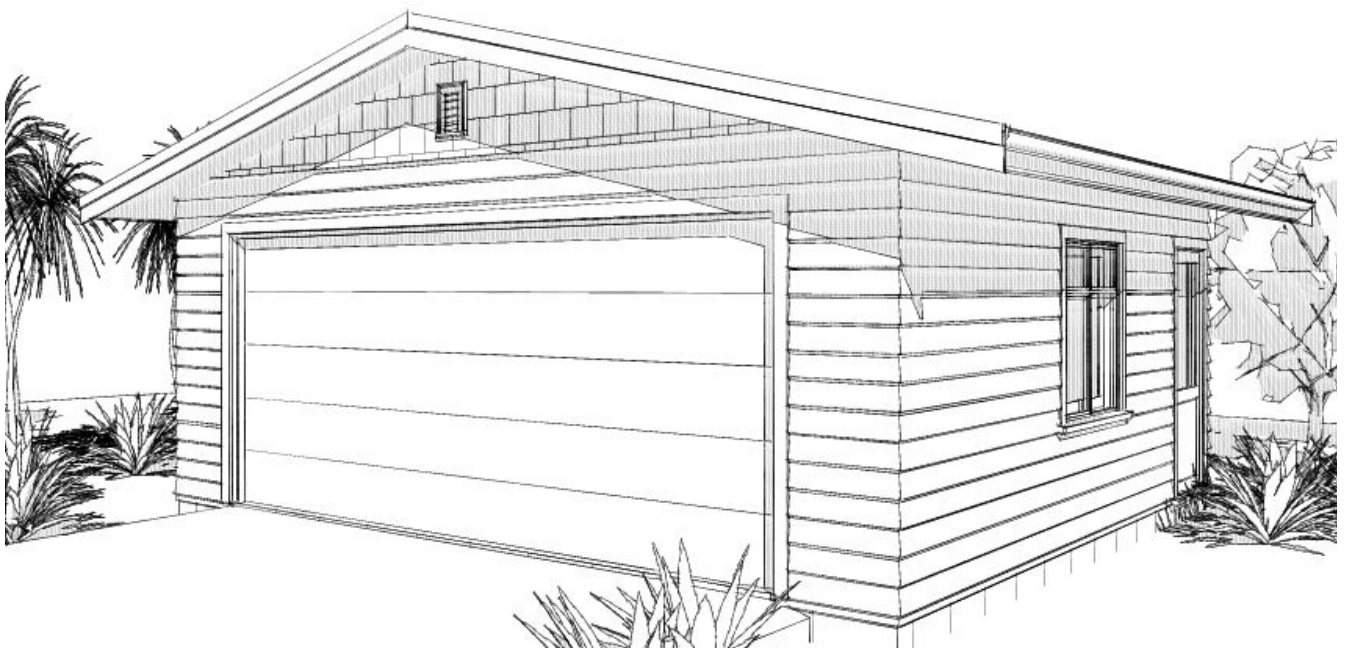

So you have your land and you're ready to build



- 1 Put together your list of 'must haves', ideas that you like and your budget. Include pictures, styles and colours that inspire you.



- 2 Meet with us for a personal consultation. We'll talk you through your ideas, your aspirations and vision for your build.



- 3 Select a house plan from the Heritage range. If you can't find the exact plan or style we'll alter one to suit, or create a bespoke masterpiece to suit your unique style. There are advantages to both methods but your site your circumstances and your requirements will largely determine which option is the most suitable for you. If you are unsure, your New Home sales Consultant will provide you with all the info you need to make this decision.



- 4 After we have considered your circumstances and ideas, we will create a set of 3D concept plans on your behalf that will give you a visual idea of how your new home will look. This step gives you an opportunity to work out the exact design you want for your new home.



- 5 Once you have determined your design, we proceed to pricing plans which allow us to put together a quote based on your design, aiming to encompass your needs and wants within your budget. This will include your selections for cladding, roofing, flooring, your kitchen plan and bathrooms. The exact cost of your build contract will be determined by several factors, some potentially unknown to us until some critical planning information is supplied, for example Site, Topographical and Engineering surveys. Your Heritage Consultant can work through these issues with you.



- 6 Once we have completed the pricing step for your home, we will present you with a build contract that outlines a proposed price for your home. If you are happy with the price on offer, we will sign the contract and request a deposit to lock your build into our schedule. The next step is to move onto submitting the final plans to Council.



- 7 CONSENT IS GRANTED.



- 8 Building Starts! The length of the build is dependent on the size and complexity of your build, but we will make this clear in the contract so you know exactly what to expect and when.



- 9 Once Certificate of Completion has been granted, its time to move in so you can start building your family's legacy in your beautiful Heritage Home.

Wishlist

Think about what items are important to you in your home.

1	_____	11	_____
2	_____	12	_____
3	_____	13	_____
4	_____	14	_____
5	_____	15	_____
6	_____	16	_____
7	_____	17	_____
8	_____	18	_____
9	_____	19	_____
10	_____	20	_____

STYLE

Think about your personal taste as well as how your belongings and furniture will fit in your new home. You need to consider colour, texture, floor coverings and window treatments.

SIZE

You need to work out what size home best suits your family and future. Consider storage space, bedrooms, wardrobe size, bathrooms, living and entertaining areas.



EXTERIOR

Think about what style home would suit your location and section. Consider the aspect of the home to capture the best view, sun etc.

FUNCTIONALITY

You need to think about what you would like to do in your home. Are you big on entertaining? Is it going to be a home and business? Do you have individual hobbies?



How is Heritage Homes different from other group housing companies?

We work to make your new home a unique build in every way. The workmanship and detail that we put into every heritage home means it is not just an off the shelf product. Not only that, you have control from the beginning and right through the build. If you have the budget and want to add more rooms, add a garage, change the ceiling height etc we can accommodate your needs.

Can I alter a plan that I like or add a Garage?

Yes, you can. In fact, 95% of our plans are adjusted to suit your needs, wants and site specifications.

If it is a minor change to our standard plans and you are not moving a load bearing wall, the additional charges are minimal. If it is a major change and you will need to move a load bearing wall, increase the designs floor area, or considerable changes to the design to meet planning requirements, this can be quoted for you at the time of concept plans.

Can I use my own architect?

We have a full inhouse design service. Our architect has worked on designing many Heritage Homes, therefore knows the ins and outs of the design process.

If you have plans already, or have someone you would prefer to work with, we are flexible and always find a way to make it work for you.

How long does it take to build a Heritage Home?

This depends on the style of the house you have chosen. The finer details and specifications of your home can make a huge difference as well. We also need to consider the site, location and council requirements and processing times.

Bad weather can play a huge part in build timelines. Seen that this is out of our control, we do everything we can to reduce the risk of delays.

A typical Avondale build can take approximately eight to nine months to complete all going to plan.

What is the square meter rate for a Heritage Build?

We don't usually work with square meter rate, there are many factors that can significantly influence the cost of building your home. Other housing companies that use square meter rates usually don't take into consideration site specifics and the finishes and changes you may want done to your home. Because of this, we use indicative pricing to give you a range of what it could cost depending on your choices.

The best thing to do is to talk with a Heritage Homes Licensee to get a better idea on what your home could cost.

What is a Master Build Guarantee?

The Master Build 10-Year Guarantee protects a homeowner when renovating or building a home. This is likely to be the biggest investment they make in a lifetime, and it needs to be protected.

The Guarantee covers the homeowner for ten years and starts at the time they sign the contract. It covers them from Loss of Deposit and Non-Completion, Materials and Workmanship, and Structural Defects. A Guarantee costs less than 1% of the build cost and adds value to your property – it is fully transferable if you sell. The Guarantee provides cover not included by general house insurance.

Do I need to go to the council for anything before I decide to build?

If you are serious about buying a section and building on it, then it is helpful to have a LIM (Land Information Memorandum) report. This will help the architect with the procedure and speed up the initial process. This holds some of the relevant information we may need to build your home.

What could affect the build cost of my new home?

Areas that can increase the cost of your home considerably are siteworks, foundations, increasing the size of the house, moving significant walls, adding windows and doors, considerable changes to the roof line and your selection of finishes in the house. With our homes it is easy to add jewellery. We can work together on this, so we don't lose vision of the overall budget you have.



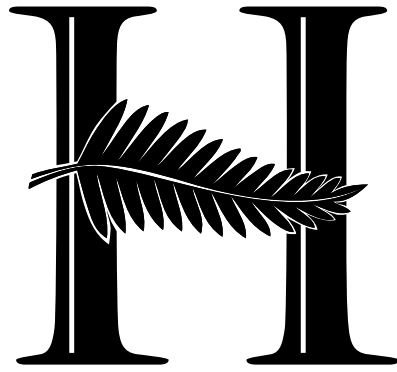

HERITAGE
~ HOMES ~
